



## BoonDocker Nitrous System Installation Instructions for SKI-DOO 1000 SDI

### Important information.

#### REGISTER THIS PRODUCT ONLINE AS SOON AS POSSIBLE

As part of our on going dedication to customer satisfaction, product updates may become available for the Control Box as more testing and development is completed. It is required that you register this product so you can receive technical support and warranty claims. We then can keep you up to date with product updates. Go to [www.boondockers.com](http://www.boondockers.com) (select **Support**, then **Product Registration**) or call 208-542-4411 to register.

Before you begin, please read all the instructions below and check kit contents.

#### **Nitrous Kit Contents:**

Quality check by:

- |  |   |
|--|---|
| ___ 2 – Nitrous Manifolds with fittings installed, 3 hole nozzle in each | ___ 1 – solenoid/transducer assembly                    |
| ___ 2 – 4-hole nozzles   | ___ 1 – jumper/battery connection                       |
| ___ 2 – 5-hole nozzles   | ___ 1 – solenoid holding bracket and self-tapping screw |
| ___ 1 – Nitrous Bottle with valve  | ___ 1 – pushbutton switch                               |
| ___ 1 – fittings for bottle  | ___ 1 – mounting clamps for pushbutton switch           |
| ___ 1 – mounting bracket for bottle                                      | ___ 1 – Nitrous wiring harness                          |
| ___ 1 – support bracket for bottle                                       | ___ 1 – BoonDocker Control Box                          |
| ___ 1 – carriage bolt, nut, washer for bracket                           | ___ 1 – EFI wiring harness                              |
| ___ 1 – bottle clamp   | ___ 6 – Cable Ties                                      |
| ___ 1 – high pressure braided hose (36")                                 | ___ 1 – dual lock for mounting box                      |
| ___ 2 – 12" length of 1/8" black nylon hose                              |   |

#### **Tools Required:**

- Drill + bits (3/4", 1/4")
- Side cutters
- 5/32" and 7/32" Allen wrenches
- Basic wrench set

#### **Theory of Operation:**

A common misconception about nitrous oxide is that it is explosive or flammable. Nitrous by itself does not burn, nor is it explosive. At 565 deg. F, nitrous oxide (N<sub>2</sub>O) breaks apart and forms two parts nitrogen and one part oxygen. Inside an engine, this added oxygen speeds up the combustion process (the nitrogen plays an important part in buffering the reaction). Whenever nitrous is used, additional fuel is necessary; otherwise the added oxygen will act as a blow-torch inside your engine. When used properly, nitrous oxide provides the same benefits as turbo charging or supercharging your engine (extra power is made by burning more fuel and oxygen), but without the added cost or complexities.

Below is a diagram of the major components of the BoonDocker EFI Nitrous System. The simplicity of this system makes it the most reliable, easy to tune, and easy to install nitrous system available. By using the existing fuel system (injectors) to add the required extra fuel for nitrous, the complexity and unreliability of extra components is eliminated.

(continued on next page)

A pressure transducer is used to monitor bottle pressure. Fluctuations in bottle temperature greatly affect nitrous pressure, which affects nitrous delivery. Once the system is tuned, the Control Box will automatically adjust the fuel delivery as nitrous pressure varies, thus making this system safe, reliable, and easy to use.

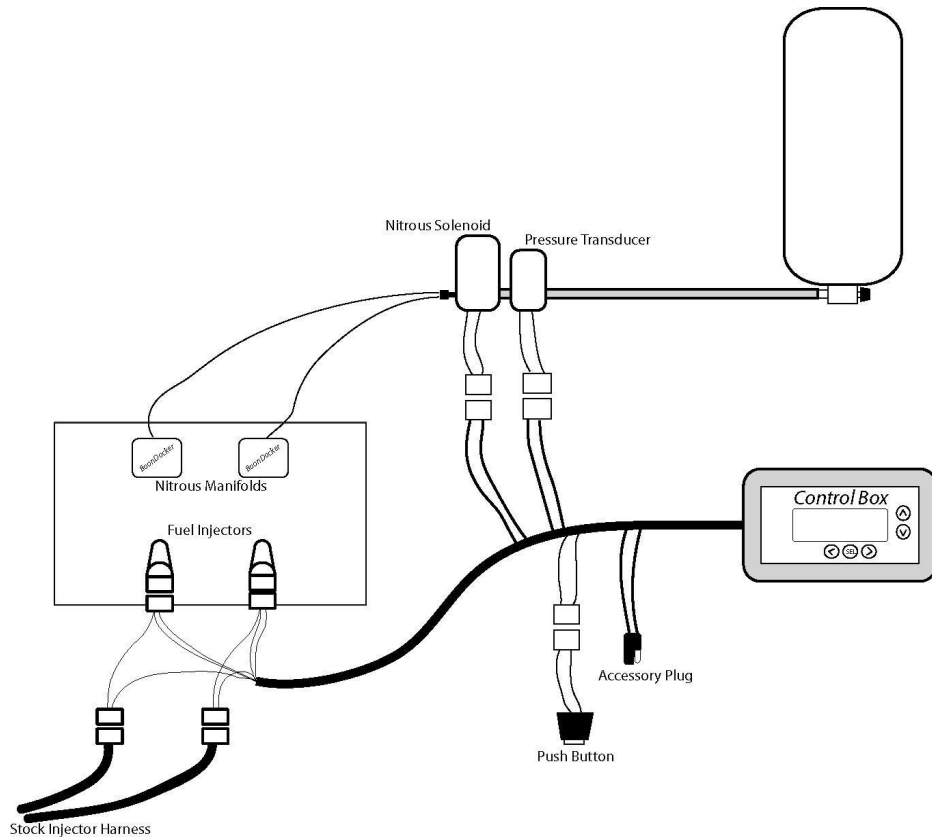

## Part I – Bottle Installation

### A. Bottle Valve Fittings

Insert the 4AN x 1/8" NPT fitting and the 1/8" NPT Plug into the bottle valve (these are attached to the lid of the box with the bottle). Use Teflon tape to seal the threads – be sure not to get tape inside the threads!

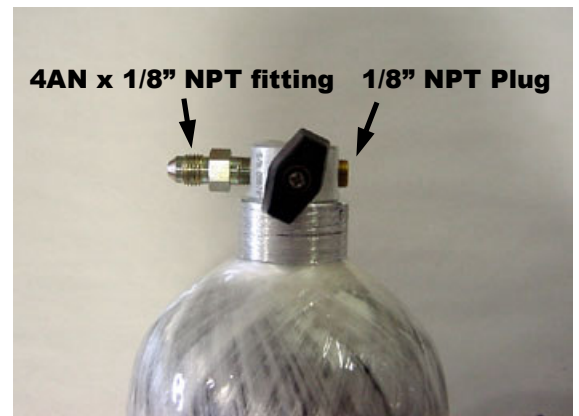

### B. Bottle Mounting Position

With nitrous in the bottle, both nitrous liquid and nitrous gas are present under high pressure (760psi at 70 deg F). Due to gravity and acceleration forces, the liquid portion of the nitrous will be at the bottom and rearward parts of the bottle. For this nitrous system to work properly, it is important that nitrous liquid be drawn from the bottle. Nitrous vapor will cause a significant decrease in performance.

We prefer not to use a siphon tube inside the bottle since the tube can sometimes come loose and move around inside the bottle. This means the bottle must be mounted so the valve is pointed down and towards the back of the sled as shown.

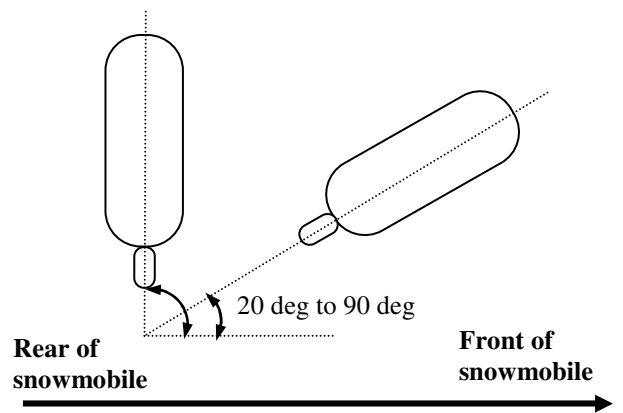

### C. Bottle Bracket

1. Remove exhaust pipe (expansion chamber and silencer).
2. Remove bulk head support bolt and ground bolt. Reinstall with saddle bracket and support bracket. Attach two brackets with carriage bolt on top left corner.

*Note: Be sure to insert bottle clamp before mounting saddle bracket You will also need to remove the factory spring holder so the bracket will sit flat against bulk head*

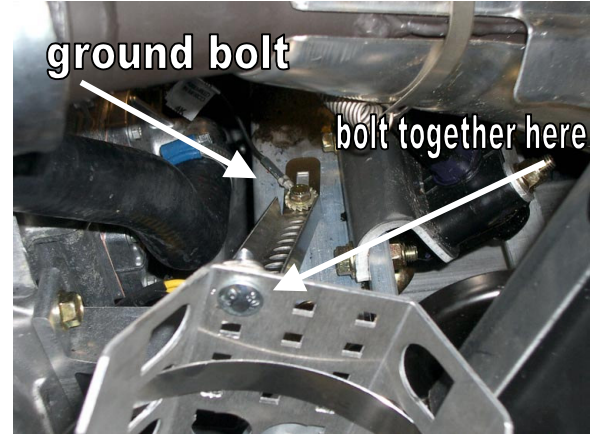
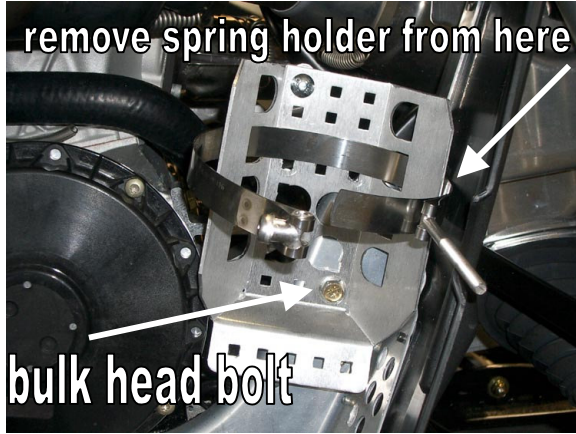

### C. Bottle Filling /Weights

Automotive speed shops that sell nitrous kits can usually refill nitrous bottles. This bottle can be filled with non-medical grade nitrous oxide that contains a very small amount of sulfur dioxide (combines with water in your lungs and forms sulfuric acid if breathed too much). This is the same nitrous that is used for all nitrous oxide systems, usually with the name “Ny-trous+”.

Fill the bottle according to the weights below. We do not recommend overfilling the bottle – when the bottle gets hot, it will rupture the blow-off disk.

<i>note: all weights are in fractions of pounds, not ounces</i>	Bottle Size		
	3.0 lb AL Bottle	2.9 lb CF Bottle	4.1 lb CF Bottle
<b>Weight of Cylinder &amp; Gas</b>	6.1 lb	6.0 lb	7.8 lb
<b>Weight of Cylinder Empty</b>	3.1 lb	3.1 lb	3.7 lb
<b>Weight of Gas</b>	3.0 lb	2.9 lb	4.1 lb

## Part II – Nitrous Manifold Installation

1. Remove side panel from sled
2. Remove airbox from side panel
3. separate airbox and remove foam from panel where nitrous manifolds will be installed.



4. Drill  $\frac{3}{4}$  and  $\frac{1}{4}$  inch hole and install manifold. Connect  $\frac{3}{4}$  and  $\frac{1}{4}$  inch holes so manifold can be installed and removed with out separating airbox. Use diagram below for a template to drill and attach holes
5. Clean airbox and reassemble, reinstall in side panel

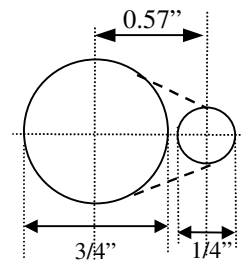
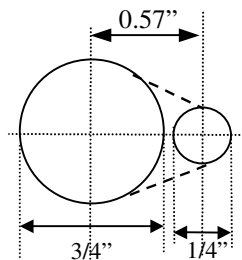
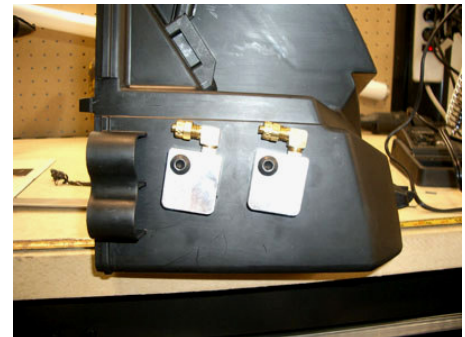

### Manifold Cutout Templates

(template is replicated 2x's - this does not show how each manifold should be mounted in relation to each other)

## Alternate Manifold Placement



### Part III - Solenoid / Press. Transducer / Hose Installation

The solenoid/transducer should be pre-assembled. Should you need to take it apart, refer to the picture (**fig 3**) to be sure it is assembled properly. Note the following:

- a. Assemble the Nitrous Filter with the filter element pointed in the direction as shown. Connect the Nitrous Filter to the side of the solenoid marked “IN”.
- b. Connect the push to connect fitting to the side of the solenoid marked “OUT”.

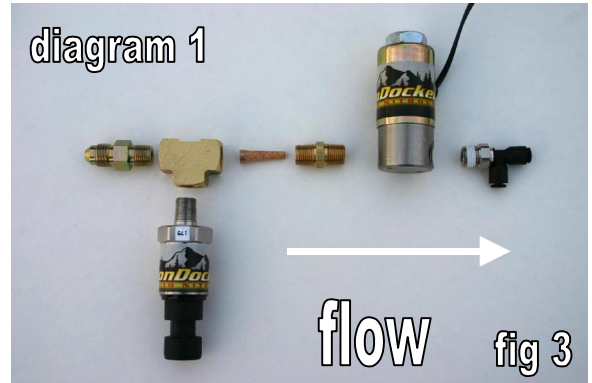

1. Mount solenoid to aluminum support in front of primary clutch using supplied self tapping screw.
2. Connect a 1/8” black nylon line from the solenoid’s push-to-connect fitting to each manifold’s push-to-connect fitting. Keep the hose away from hot items. **If the line needs to be trimmed - be sure to cut the black line straight off to prevent a leak.**

**Note:** It does not matter which line goes to which manifold. It is best to try and keep both lines close to the same length so nitrous will reach both manifolds at the same time.

3. Connect the high-pressure braided hose from the bottle to the solenoid. These are 4-AN fittings that have matching flanges that form a seal – **do not use Teflon tape on these fittings!**
4. Secure braided hose to aluminum support to prevent it from touching exhaust pipe.

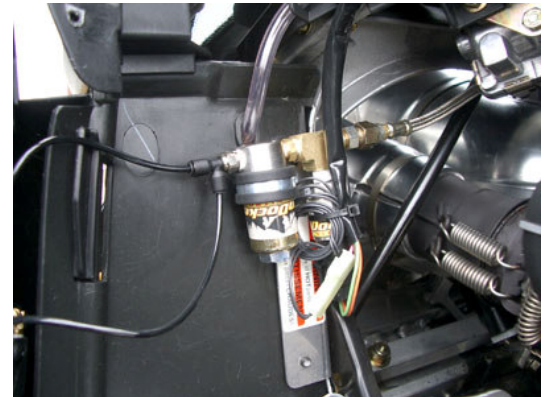

5. In order to mount the nitrous manifolds in the inner air box the solenoid will also need to be mounted closer to the inner air box. You can use the mounting strap and the self tapping screw to mount the solenoid/transducer assembly to the aluminum brace directly in front of the inner air box. Note: You can use the bolt used earlier to mount the ground for the control box with the solenoid/transducer in front, running parallel with aluminum hoop.

## Part V – Push-Button Installation

The pushbutton switch can be installed on the left handgrip. Shown are directions for installing the button on the left so the button can be pressed with the thumb.

There are two clamps in the kit. The one with the screw is only useful if the button needs to be mounted directly to the handlebar. Directions for mounting the button directly to the handgrip using the crimp-on clamp are shown below:

1. Using pliers, bend a hook into one end of the clamp.
2. Connect the clamp to the button as shown. Fit the hooked part of the clamp to the button so the straight part of the clamp is not connected.
3. Put the button on the left handlebar. With a pen, mark on the clamp where the mounting hole on the button and the clamp meet.
4. Remove the clamp and cut it approximately 1/4" to 3/8" away from the mark. Bend this end with pliers so it is similar to the other hooked end.
5. Put the button and clamp back on the handlebar. Tighten the clamp with side cutters so it is just snug. Do not over tighten.
6. The button should appear as shown in the picture.

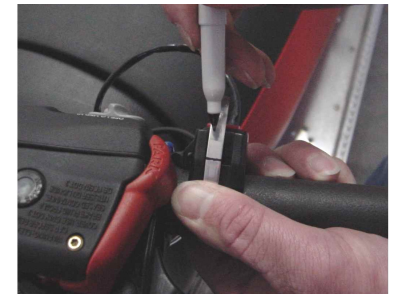
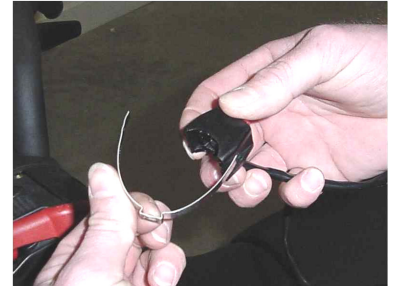
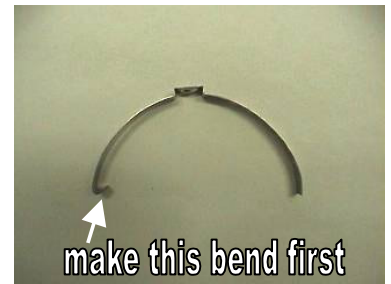

## Part VI - ELECTRICAL INSTALLATION

### A. EFI Harness installation

Please refer to the Control Box Instructions for steps on how to install the EFI harness.

### B. Nitrous harness installation

1. Find the round 3-pin plug with a purple seal on the Nitrous Harness. Plug this connector into the pressure transducer that is located next to the nitrous solenoid.
2. There is a plastic 2 pin connector (pink / purple wires) next to the transducer plug – this connects to the nitrous solenoid.
3. Run the harness up along the tube frame next to the previously installed EFI harness. Secure both harness's to the square tube with supplied zip ties.

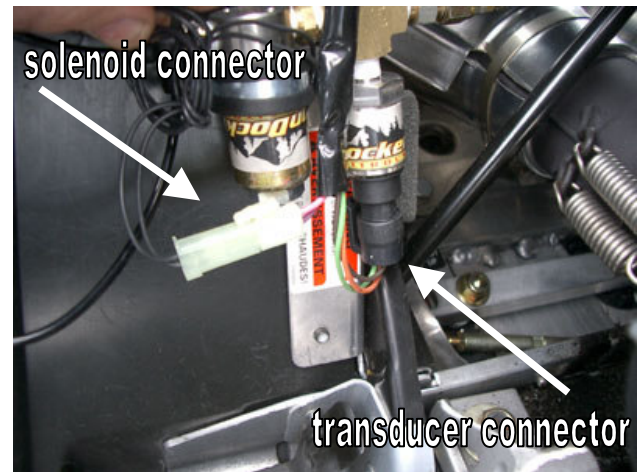

4. Plug the remaining 2-pin connector (brown / tan wires) into the nitrous button (black & black w/white).

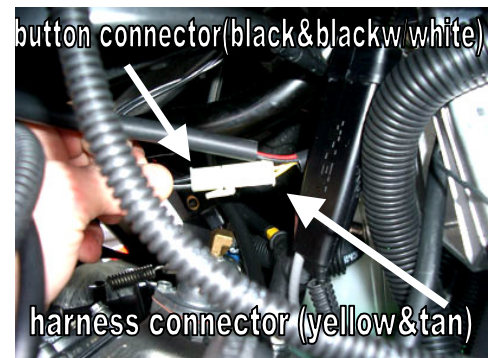

5. The remaining 2 wire rubber molded connector connects to the sled's accessory power connector as follow:

- A Plug the adaptor into the two pin molded connector. Remove the windshield/instrument cluster assembly by removing the four torx headed screws.





- B Plug the spade connectors into the factory harness female spades. Be sure and plug the red (positive) male connector into the red female connector on sled, as well as the brown male connector plugs into the black female connector..

**NOTE**

Make sure that both terminals are insulated properly, using black electrical tape to prevent either terminal from shorting to ground. This may cause drivability problems if either terminal can short to ground

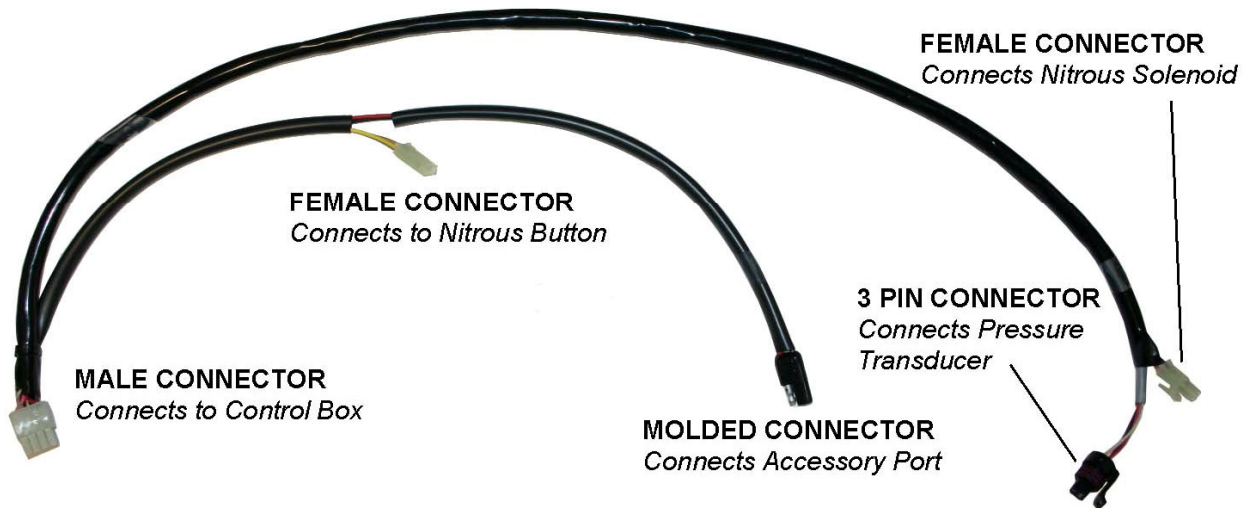
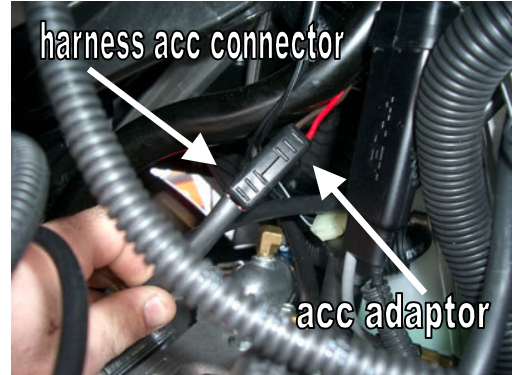
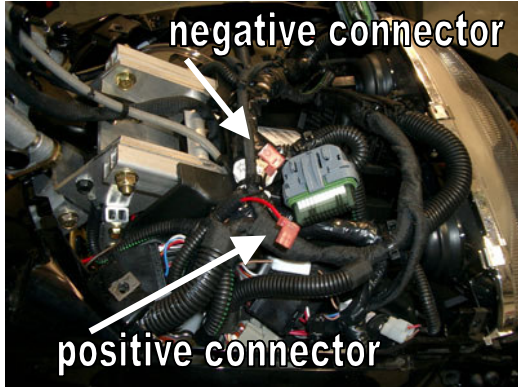

## Part VII - Startup and Tuning Procedures

### **A. Important Notes before using Nitrous:**

1. We strongly recommend using high-octane fuel (at least 94 for most stock motors, more for modified motors). We have found that race fuel or race fuel concentrate (made by Torco or Klotz) mixed with premium gas can provide the necessary octane.
2. We also recommend using one size colder spark plug (higher number = colder). In some cases decreasing the spark plug gap an additional .003”-.005” (around .018-.020”) achieves best results.
3. Be sure to use filtered nitrous – always use a filter when filling your bottle!
4. When tuning the system, do not use nitrous for more than 2 seconds at a time. Once the system is properly tuned (see steps below), we recommend not using nitrous for more than 8 seconds at a time. If nitrous is used for longer durations, it is critical that the system be carefully tuned and that no detonation problems are occurring.

### **B. Startup & Leak Test Procedure**

The rider must do the following steps every time the bottle is turned on and before doing the fuel adjustment procedure.

1. With the engine off, open the bottle valve and check for leaks. Shut the bottle valve off. With the valve shut, the hose will still have pressure in it.
2. With pressure in the hose and the bottle valve closed, start the engine. Check to make sure the solenoid does not discharge hose pressure.
3. With the engine running (be ready to shut down engine if necessary), open the bottle valve. Push the nitrous button for about one second or less. Engine rpm should increase if the nitrous system is functioning properly.

### **Warning: Only adjust the Control Box settings according to the steps below.**

The steps below should be done with a full nitrous bottle that is at the proper operating temperature (70-90deg F) and pressure (700-1000psi). Make sure the engine is at normal operating temperature.

### **Do not exceed 2 seconds of nitrous use until the fuel adjustment is complete and correct.**

This adjustment process should only be performed by an experienced tuner. If you are not an experienced tuner, find someone who is. Remember, safety first!

1. Increase the nitrous fuel adjustment setting on the Control Box until you notice a drop in the power increase when using nitrous. When this occurs, you are rich. Be sure you have reached this point before proceeding. Note this adjustment setting.
2. Only after step 1 is complete, start reducing the fuel setting. Continue reducing the fuel setting until a maximum power increase is obtained. This can be determined by noticing your maximum RPM.
3. If the fuel is reduced but no power increase is noticed from the previous setting, this means you are lean. Note this adjustment setting.
4. Increase the fuel setting back to where it was before no additional power increase was noted in step 3. This setting should be somewhere between the rich and lean settings. It is best to stay on the rich side.
5. After this adjustment is made, if the engine does not run perfectly smooth when using nitrous, do not use it! If the exhaust note does not sound clean, the cause is likely detonation, which can quickly destroy the engine. Use higher octane fuel, add more ignition retard, reduce the engine’s compression, or reduce the amount of nitrous (see next section for changing nozzles) before using nitrous again.

## Part VIII – Changing Nitrous Manifold Nozzles

It is possible to increase/decrease the amount of nitrous the nitrous manifold sprays by replacing the 3/4" nozzles with nozzles with more/less orifice holes. In general, each orifice hole that is sprayed is equivalent to a 4-5hp increase.

### Read this before you increase nitrous!

Be sure your engine is working good before you decide to increase the amount of nitrous. If you are not getting the power increase you are expecting with the original setup, something is likely wrong. Review the nitrous tuning procedure and verify that you can add fuel so you know there is too much fuel. From there, if leaning the nitrous fuel adjustment setting does not produce an increase in power, one of the following problems may exist:

1. Be sure your bottle is full, at the correct temperature (70-90 deg), and positioned correctly so the valve picks up liquid nitrous. The system will not work properly if nitrous vapor is being picked up or if the bottle is too cold.
2. Your engine could be detonating. Detonation can occur if your compression ratio is high, your timing has been advanced, or you are not using good octane fuel. Listen carefully to the motor - if it does not sound clean and you are not too rich, you are likely detonating.
3. A bad power source or faulty electrical connection may cause the nitrous system to malfunction intermittently. Carefully check all connections. If necessary, solder all connections.

**Important Note:** A known problem exists on some snowmobiles when the lighting system has been disconnected (often when the hood has been removed). The voltage will be fine at an idle, but when revved up, the voltage regulator will become overloaded and the voltage will drop, causing the nitrous solenoid to no longer work. Either reconnect the headlight so there is enough load on it, or install a power resistor (available from Boondocker).

4. Dirty nitrous can quickly plug the nitrous filter and obstruct the nitrous delivery. Remove and clean the sintered bronze filter element by blowing compressed air through it backwards. Always fill your bottle from a filtered source.

### Installing / Removing Nozzles

1. Remove the nitrous manifold from the air box.
2. Use a 7/32" hex wrench to carefully remove/install a nozzle. Be sure the o-ring is still in place before threading in a new nozzle. Be very careful not to over tighten the plastic nozzle – it needs to be just snug.
3. If you want to increase nitrous delivery, increase the total number of nozzle holes by one! (i.e. go from 3 holes to 4 holes, etc.)
4. Retune the nitrous manifold according to the instructions above. Anytime the orifices are changed, the nitrous manifold pressure will change so retuning is necessary.

## Part IX – Warranty, Terms & Conditions

**Returned Goods** – No merchandise will be accepted without prior approval. A RMA number (Return Merchandise Authorization) provided by Boondocker is required before a return will be accepted. A 20% handling and restocking charge will be applied to returned merchandise. No unauthorized returns will be accepted.

**Limited Warranty** – Boondocker warrants its product to the original purchaser against workmanship defects for a period of 90 days, commencing from the date of product delivery to the Consumer.

**Maximum Liability** – The maximum liability of Boondocker in connection with this warranty shall not under any circumstances exceed the price of the product claimed to be defective.